

Off line localisation of a mobile robot using ultrasonic measures

Philippe Hoppenot, Etienne Colle and Christian Barat.

CEMIF - Complex Systems Group - University of Evry, 40 rue du Pelvoux, 91020 Evry Cedex, France.

e-mail: hoppenot, ecolle, Barat | @cemif.univ-evry.fr

ABSTRACT

In the scope of disabled people assistance for object manipulation and carrying, the paper focuses on the localisation for mobile robot autonomy. In order to respect strong low-cost constraints, the perception system of the mobile robot uses sensors of low metrological quality, ultrasonic ring and odometry. That poses new problems for localisation in particular. Among different localisation techniques, we present only off-line localisation. With poor perception means, it is necessary to introduce a priori knowledge on sensors and environment models. To solve the localisation problem, the ultrasonic image is segmented applying Hough transform, well-adapted to ultrasonic sensor characteristics. The segments are then matched with the room, modelled and assumed to be rectangular. Several positions are found. A first sort, based on a cost function, reduces the possibilities. The remaining ambiguities are removed by a neural network. It plays the part of a classifier detecting the door in the environment. Improvements of the method are proposed to take into account obstacles and non rectangular room.

Experimental results show that the localisation operates even with one obstacle.

INTRODUCTION

For a few years, new robotic solutions to disabled people assistance have been developed. They are realistic only under two conditions. The first one concerns the philosophy of the assistance. The system must not « do for the person » but must compensate for the person deficit of action. In fact, a Man Machine Co-operation is essential. The human degree of participation begins with very simple interventions of the person in perception or decision functions and ends with a total teleoperation of the robot. This is a semi-autonomous system. The partial autonomy of the system completes the possibility of actions of the person either to palliate deficiencies due to disability or to realise fastidious actions, « go to » for example.

The second condition is obviously the cost of assistance¹. This strong constraint limits the degree of freedom of the machine by decreasing its perception capacities and treatment power. Co-operation aims at supplying the deficiencies of the machine with the means of perception, decision and to a minor extent action of the person.

Among the main functions of today's life listed by WHO (World Health Organisation), some can be done with a robot: to carry, to grasp, to pick-up, to move. A project of a manipulator arm embarked on a mobile robot², in collaboration with AFM (French Association against Myopathies), is being developed to reach those objectives.

Under the two conditions seen before, the localisation of the mobile base has been developed. This function is indispensable for autonomous displacement.

The problem is to localise a mobile robot in a partially known environment (with unknown obstacles) thanks to a system of perception restricted to an odometer and an ultrasonic ring. Odometry is well-known for its systematic error increasing with the distance covered, and its non-systematic error due to slippage on the floor³. The use of ultrasonic sensors is usually limited to the proximetry because of poor metrological characteristics: mean axial resolution, low lateral resolution, and high rate of wrong measurements.

In that difficult context, three levels of behaviour are used in the localisation function. They are well suited to the different situations encountered. Each level uses specific algorithms, little sensitive to the high rate of wrong measurements and to the presence of obstacles (by definition not modelled).

In the first level, the robot knows approximately its position and orientation. They are updated on-line by the odometer under the control of the ultrasonic sensors. When the robot sees it is lost (the decision can be taken in collaboration with the human operator), off-line localisation level is activated. The third behaviour level corresponds to the human intervention. The supervisor analyses the situation thanks to two kinds of information: sensor measurements displayed on a 2D plan of the environment and an indicator of the quality of the position given by the algorithm running on the mobile base.

In this paper, only the off-line localisation is presented. After a state of the present art, the three stages of the method are described: the data pre-treatment which is here a segmentation, the research of several possible positions and then the choice of the best position. One improvement is proposed by using the second echo of the ultrasonic wave to decrease the effect of obstacles along the walls. Finally, experimental results validate this approach.

ABSOLUTE LOCALISATION

In the literature, absolute localisation is principally based on two techniques: construction of segments (with measurements) to be compared with the environment and grid building. Segment construction can be performed with ultrasonic sensors, taking into account errors and uncertainties on the measurements⁴. A segment is built with three points. It is kept if the construction error is less than a predefined threshold. A new point is associated to a segment if the distance between the segment and the point is less than another predefined threshold. Built segments are then compared with the environment to find the position of the robot. They can also be used to build a map of the environment⁵. McKerrow builds segments from ultrasonic data⁶. A measure is represented by an arc of circle tangent to the target wall. The arc limits are given by the cone aperture of the sensors. From another position, this same wall gives a second arc of circle. It is then possible to build the wall taking the tangent of the two arcs of circle. In Blanche project, Cox uses a laser to obtain a panoramic measurement of the environment⁷. Knowing approximately the position of the robot thanks to odometry, measures are matched with the closest segment of the environment. Measurement groups are then much easier to create.

The second technique for absolute localisation uses grids. Elfes presents a three level grid representation, depending on the objective⁸. More recent works develop occupancy grids⁹. A grid cell corresponds to the probability of occupation by an obstacle. Local maps, associated to a sensor, are updated and merged to obtain a global map which can easily be compared with the knowledge of the environment. These two techniques can be combined¹⁰. The idea is to use the natural function of the grid: matching measures with the environment.

Other techniques are also used. Kalman filter is used to find the position of the robot with an approximate position given by the odometry¹¹. Several ultrasonic sensors (one emitter and several receivers) can be used to obtain more information¹². A Kalman filter is also used to find the position of the robot. Bozma proposes to analyse the wave amplitude to build a more precise map of the environment¹³. Peyrodie treats ultrasonic data thanks to the theory of possibilities to build environment by signature analysing of the received signal¹⁴.

According to all these papers, the main difficulties are to extract pertinent information from the sensors and to match it with a priori knowledge of the environment. A specific data pre-treatment is performed before those two fundamental steps.

Two absolute localisation families exist: on-line localisation (during the mission) and off-line localisation (the mission is interrupted). In the first one, from a starting point, the odometer allows localisation of the robot with correction given by the ultrasonic measurements matched with the known environment¹⁵. The matching rate measures the coherence between the odometry and the telemetry. Nevertheless, if this coherence is too small, this kind of correction is no longer sufficient. The robot position must be determined off line with only ultrasonic measurements and the a priori knowledge of the environment. The present paper deals with this specific issue. General principles are presented. Then experimental results are given.

METHOD OF THE RECTANGLE

The problem is to find the position of a robot in a room using only ultrasonic measurements (Figure 1) and a priori knowledge on the environment (Figure 2). One obstacle can be present in the environment. The aim of this article is to find a way to match ultrasonic scanning and a priori knowledge on the environment.

A three stage method is classically used in problem resolution. The first stage consists in data pre-treatment thanks to a priori knowledge on the data acquisition process and the environment. Then, a set of several possible solutions is determined. Finally, different criteria depending on the objectives permit the choice of the best one. Before studying these three stages, a model of the sensors is presented. It is useful to determine different parameters of the algorithm.

Sensor model

Ultrasonic technology presents the following metrological characteristics (Figure 3): mean longitudinal resolution $\Delta\rho$, low lateral resolution $\Delta\theta$, and a high rate of wrong measurements due to multiple reflections as noticed by numerous authors. The wrong measures principally depend on the environment complexity and the aperture cone of the ultrasonic wave. Nevertheless, this cone is useful: it allows correct measurements even if the sensor axis is not perpendicular to the target surface (specular reflection). In that case, the measure corresponds to the closest distance between the sensor and

the object. The sensors used here are Polaroid®, characterised by $\Delta\theta=15^\circ$, $\Delta\rho=2.5\text{cm}$, a 10m range, and a 50kHz frequency. The perception system of the mobile robot is a seven sensor ring, one sensor each 30° on the front half-circle of the robot. The seven axes of the sensors join in the rotation centre of the robot. To obtain a panoramic measure set of the environment, the robot turns around itself and gives about one measure per degree. The robot is circular with two independent driving wheels equipped with optical encoders.

Off line localisation with ultrasonic sensors is performed using the three stages defined before. Pre-treatment stage consists in grouping measures together in segments. The method is taken from a segmentation technique for vision systems. The second stage is based on the hypothesis that the room is rectangular. This is a reasonable hypothesis in an indoor environment. Incomplete segments are grouped together to form partial rectangles (three or four sides). The completeness of the segments is obtained by extending them up to crossing points. Then the matching of these partial segments with the environment gives a set of possible positions of the robot. The third stage consists in choosing the best position among the proposed ones. Firstly, a cost function is maximised. Because of the rectangle symmetry, two positions can not be distinguished. A discriminant element of the environment (the door) allows the ambiguity to be solved. Classification capacities of neural networks is well suited to such tasks.

First stage: segmentation

It corresponds to data pre-treatment in which measures are grouped together. Non-significant points, far away from the room model or isolated, are rejected. A well suited transformation is applied before grouping the measures.

Hough transform

Several segmentation methods of a set of points exist. They do not take into account specific characteristics of the measurement system. As shown in the model described in the beginning of this section, each sensor of the ring gives the smallest distance to the target, meaning the perpendicular one. Hough transform (Figure 4) gives a well-suited representation of ultrasonic measurement. Indeed, the representation of a straight line in the (x,y) plan becomes a point in the (ρ,θ) plan if all the measures come from the same point of view. The axes of the sensors of the ring cross in the rotation centre of the robot; measurements seem to come from the same point¹⁰.

In this representation, measures coming from the same wall are near in the sense of the Euclidean distance. If the equation of D is $ax + by + c = 0, c \geq 0$ and $a^2 + b^2 = 1$ in the (x,y) plan, it is $\rho_0 = c$ and $\theta_0 = \text{sign}(-b) \times \arccos(-a)$ in the (ρ,θ) plan.

Taking into account measurement system errors (Figure 3), measures coming from the same wall are not represented by a point but a set of points contained in an ellipsis. Its axes are $\Delta\rho$ and $\Delta\theta$.

Measure groupments

First, measures longer than the environment dimensions are filtered. The filter threshold is called L_{\max} . Measures are represented in a (ρ,θ) matrix. The sizes of the cells are L_ρ and L_θ , respectively in meters and radians. L_ρ must be superior to $\Delta\rho$ to be consistent with the precision of the ultrasonic sensors. It depends on the position precision wanted and the number of points in the scanning set. The second dimension is defined by sensor characteristics: $L_\theta = \Delta\theta$, half angle of the aperture cone of the sensor. In this plan, the number of impacts per cell, N_{ij} , is calculated. It is then possible to determine cells corresponding to isolated measurements by fixing two thresholds. The first one, S_{\max} , defines cells in which there is a sufficient number of points to build a segment. It depends on L_θ and on the total number of measures. A second threshold, S_{\min} , defines cells in which there is a sufficient number of points to be grouped with another one to reach S_{\max} impacts. Thanks to this second threshold a group of measures separated in two cells on the ρ direction can be taken into account: $S_{\min} = S_{\max}/2$. These two kinds of cells are kept and grouped together using the four neighbour method. That gives the following distance between two cells:

$$D_4^{\text{PPV}}(C_n, C_m) = |x_n - x_m| + |y_n - y_m|$$

where x_n, x_m, y_n and y_m are the co-ordinates of cells C_n and C_m .

Second stage: search of several possible positions

First, longer segments are built by aggregation of segments which have a specific orientation and respect proximetry criteria. Those longer segments are grouped to build partial rectangles (with three or four sides). They are then matched with the environment to obtain a set of possible positions.

Segment aggregation

The forward stage gives an important number of short segments. They do not give a proper representation of the walls of the room because several of them belong to the same wall. So, some segments are aggregated to longer ones. Two segments belong to the same wall if they have nearly the same orientation (difference less than θ_{\max}) and if their extremities E_{S1} and E_{S2} are near enough. It is interesting to favour the longer segments. Indeed, uncertainty on their orientation is less than for the shorter segments. A variable distance is defined as $d_{\max} = (L_{S1} + L_{S2})/10$ where L_{S1} and L_{S2} are respectively the lengths of the considered segments S1 and S2. It represents the threshold of the distance between the two segments. θ_{\max} is fixed taking into account the cone aperture of the sensors ($2 \cdot \Delta\theta$) with an added uncertainty ϵ . ϵ allows aggregation to be privileged and limits the number of final segments. To sumup, two segments are aggregated if and only if:

$$\begin{cases} d < d_{\max} \\ \alpha < \theta_{\max} + \epsilon \end{cases}$$

where d and α are defined in Figure 5.

Rectangle building

Usually a room is rectangular. So it is interesting to find, among the segments computed above, those which are perpendicular. Two segments belong to the same group if the difference of their orientations is multiple of $\pi/2$, more or less 10% to take into account measure uncertainty. Only groups with at least three segments are used in the following.

Matching with the environment

In that step, environment is represented as a rectangle, without taking the door into account. For each group of built segments, segments are extended to find the corner of the room. Then, the matching principle consists in finding a segment which has the same length as a wall of the modelled room with a tolerance S . S must be as $S \leq (L+1)/2$, where L and l are respectively the length and the width of the rectangle of the model, to guaranty that a computed segment cannot be matched with both length and width of the model. If $S = (L+1)/2$ is chosen, no segment is rejected. In that limit case, the number of possible positions is the largest which can be obtained. It is the choice made here. Experimental results will show that it is a good choice. If a measured segment is matched with a modelled one (thanks to S), two symmetric positions are possible (Figure 6).

If a group of calculated segments contains only three segments, the first operation is to find the segment perpendicular to the other two: it is the only one whose length is known.

Third stage: choice of the best solution

Firstly it consists in defining a cost function for the found positions and to keep the most interesting one. It appears that two positions have the same cost. That comes from the rectangle symmetry. This ambiguity is solved thanks to the only non-symmetric element of the room: the door. A neural network is used to recognise the door and solve the position ambiguity due to the symmetry.

Cost function

For all positions, a satisfaction rate is calculated from the measurements and the environment knowledge. For each solution, measurements are matched to the environment using the smallest distance between a measure impact and the walls of the environment. Measures superior to L_{\max} , outside the environment, are rejected.

The first idea is to use the sum of the squared distances between measures and the environment:

$$F_1^P = \sum_i D^2(M_i^P, E)$$

where M_i^P is the measure number i at position P , E the environment and D the distance function between a point and the environment. It corresponds to the minimum distance between the impacts and all the segment of the environment. It is:

$$D = \min_{j=1}^{N_S} (d(M_i^P, S_j))$$

where N_S is the number of segments of the environment and d the distance between a point and a segment defined as follows:

$$d(M,S) = \min \begin{cases} \text{dist}(M, \text{Drte}) & (d_0) \\ \text{dist}(M, E_1) & (d1) \\ \text{dist}(M, E_2) & (d2) \end{cases}$$

where Drte is the straight line of the segment S, E₁ and E₂ are the two extremities of the segment. d₀, d₁ and d₂ are defined on Figure 7.

F₁^P is the more intuitive cost function but it gives an excessive weight to the wrong measurements (far away from the environment) which are probably due to multiple reflections.

To give a more important weight to the measures matched with the environment, the cost function used is the inverse of the squared distances between measures and the environment:

$$F_2^P = \sum_i 1/D'^2(M_i^P, E)$$

where D'=D if D(M_i^P, E) ≥ d_{min} and D'=d_{min} else to avoid a division by 0. d_{min}=2*Δρ is chosen taking into account imprecisions on the measures and the position of the robot during the rotation performed to obtain measurements. This function measures the number of points near the environment. In that case, the error minimisation is given by searching a maximum of the function.

The optimisation algorithm used to maximise F₂^P is initialised with a position and orientation of the robot which determine the position of the grid in relation to the measures. This initialisation can favour certain solutions. It is then useful to run the algorithm with different initialisations. If the same position is found by different runs, the different costs are added to strengthen the associated choice.

The rectangle symmetry does not allow the positions proposed in Figure 6 to be distinguished: a position ambiguity subsists.

Taking off the position ambiguity

The symmetry of the environment induces a localisation ambiguity (two hypotheses Figure 6). A door can be used as a landmark which breaks the symmetry of the room. Finding this door is a typical pattern recognition. Literature proposes several approaches to solve the classification problem particularly neural networks and statistical methods. It depends on the application constraints and on the a priori knowledge on the input data and physical phenomena. Neural networks are more effective and economic than the statistical methods when natural data are not describable by low-order statistical parameters, their distribution are non-Gaussian, their statistic are non stationary and the functional relations between natural data elements are nonlinear¹⁶.

Generally, the best classifier for a given task can be found by comparing different methods thanks to several criteria: classification error, computational complexity and hardware implementation efficiency¹⁷. For example, k-nearest-neighbour method, whose computational cost is important, is rejected because of the real time constraints of our application. Four methods have been compared: two statistical ones, Linear Discriminant Analysis¹⁸ and Quadratic Discriminant Analysis, and two neural ones, Learning Vector Quantisation and MultiLayer Perceptron. Table 1 shows that the MLP gives the best results. It is a neural network with 15 inputs (which corresponds to an angular sector superior to the beam aperture of the sensor) with 19 neurones in the hidden layer. We adopt the procedure of cross validation to train the networks. Data sets are divided in three equal parts to produce a learning data set, a validation data set and a generalisation data set¹⁹. For the MLP and LVQ, different architectures and initialisations have been tested and compared thanks to the generalisation error. The bad results of QDA and LDA come from the non-gaussian distribution of the data.

	MLP	LVQ	LDA	QDA
Good detection	42.1%	52.0%	13.7%	10.8%
Wrong detection	4.5%	13.4%	4.5%	14.3%

Table 1: Comparison between the four studied methods.

In the experimental case which aims to compare different methods, the good classification rate of the MLP (42%) seems to be a low level recognition rate. In this case, there is no hypothesis on the door position. In fact, the rectangle algorithm gives only two hypotheses. In that case, results given latter show the efficiency of that classifier. The search of the door with the neural network is limited to two angular sectors (one for each proposed position). The detection of the

door is in fact the detection of the two door pillars. A criteria, C, allows the robot to distinguish which is the better position of the two. It is defined as follows.

α_1 and α_2 are the angles of view of door pillars number 1 and 2. A cone of $\pm\Delta\alpha$ amplitude is defined around these two directions. For all the directions inside the cone, neural network responses are added. So:

$$\det_{p \in \{1,2\}, j \in \{1,2\}} = \sum_{\substack{\beta_i \leq \alpha_j + \Delta\alpha \\ i, \beta_i \geq \alpha_j - \Delta\alpha}} \det_{p,j}^{\beta_i}$$

where p is the calculated position of the robot, j is the number of the door pillar, β_j the angle of view and $\det_{p,j}^{\beta_i}$ is the output of the neural network of detection of the door pillar number j for the angle β_j from the position p.

So, for each position, two values are computed. The quality of detection of position p is defined by:

$$\det_{p \in \{1,2\}} = \sum_{j=1}^{j=2} \det_{p,j}$$

which is the sum of the detections of door pillars 1 and 2. The comparison between \det_1 and \det_2 is performed by the following normalised difference:

$$C = \frac{\det_1 - \det_2}{\det_1 + \det_2}$$

Its sign gives the dominant position and its value the validity of the choice.

Improvement of the method of the rectangle

The presence of obstacles masks the rectangular characteristic of the environment which is the central point of the algorithm. The classical phenomenon of multiple echoes of the ultrasonic wave permits to palliate this problem. Indeed, the first echo sees only the nearest object to the sensor. With the second echo, it is possible to see the object behind.

In the case of a clustered environment, few echoes come from the known environment: an obstacle is seen before the wall (d1). But a second echo (even a third one), d2, can come from the wall after the obstacle (Figure 8). So it is interesting to have several echoes for each sensor. Then the problem is that several measures come from multiple reflections, giving wrong values.

The interest of the technique is that walls partially hidden by an obstacle can be seen. Thus the rectangularity of the room, the principal characteristic used by the algorithm, is better detected.

EXPERIMENTAL RESULTS

Three kinds of results are presented. The first ones correspond to the method of the rectangle without neural networks. Because a position ambiguity is still present, neural networks are used to take it off. Finally, the case of the modified method of the rectangle, using the second echo, is developed.

Before the presentation of these results, experimental protocol is given. Then, segmentation is illustrated by an example.

Experimental protocol

The robot being at an unknown position in the environment (Figure 2), what are the correct measures to find its position? About 400 measures are obtained (Figure 1), more than one measure per degree.

Erroneous measures appear. Most of them come from multiple reflections. Measures out of range (size of the room) are not used: knowledge of environment dimensions allows such measures to be rejected.

More, it is impossible to make the distinction between a wall and a corner, a well-known result with this type of sensors²⁰. In first approximation, both are represented by arcs of circle. Indeed, measure given by the sensor is always the smallest distance to the measured object. Measurement can come from any point of the angular sector AS. The impact is represented on the emission axis (Figure 9). So, when the obstacle is visible, the measured distance is always the same whatever the sensor orientation changes.

First stage: segmentation: example

Hough transform

For the measures shown in Figure 1, Hough transform gives the result of Figure 10. Uncertainties in θ direction, more than $\Delta\theta$, can appear. Indeed, a plane and a corner give the same image. If a corner follows a plane, both can be mixed in one arc of circle. A group of measure can then be longer than $2*\Delta\theta$ in θ direction. That explains the ellipsis drawn on Figure 10 have an axis along θ longer than $2*\Delta\theta$.

Grouping measurements

The segmentation method described before gives the results of Figure 11, with the same example. Those groups of points spread largely in θ direction. The corresponding computed segment is then strongly biased. So, cells of the group are classified following θ . Several small groups, with maximum two cells in θ direction, are built.

In our case, parameters are fixed as follows. Firstly L_{max} , the biggest dimension of the environment, is fixed to 5m. Then, the sizes of the cells are $L_p=0.25m$ and $L_\theta=\pi/12$, applying rules presented in the first stage of the method. Filtering thresholds are fixed using the number of measures (400) which corresponds to more than one measure per degree. If a cell contains at least 15 points (one per degree), they come from the same wall. That gives $S_{max}=15$. The last threshold is then: $S_{min}=8$.

In this example, the initial number of points is 406. It falls to 242, filtering about 40%.

Second stage: the method of the rectangle

Results are given in two cases. In the first one, there is no obstacle in the environment. The method of the rectangle, before using the cost function, gives several positions (Figure 12 and Figure 13). They are symmetrical, two by two, with respect to rectangle centre. It is because of the symmetry of the rectangle.

Third stage: choice of the best solution

The cost function

The cost function described in the third stage of the method is represented in percentage as follows:

$$F_{\%} = 100 \times \frac{F(i)}{\sum_{j=1}^{N_p} F(j)}$$

where N_p is the total number of proposed positions (6 in this example).

Two positions are much better than the others. They form a pair of symmetrical positions with respect to the rectangle centre. This ambiguity cannot be solved if only the rectangular form of the environment is considered. A more precise analysis of the set of allows recognition of the door and solution of the ambiguity (see following §). Excluding this ambiguity, on six experiments in the room without obstacle, the correct position is always found with a precision better than 15cm and 5° .

In the second case, an unknown obstacle is introduced in the environment. Some part of information is then lost. First results are worse than before. On 14 sets of points, 6 give the correct position (less than 20cm and 10° error), 3 give a mean position (less than 40cm and 20° error) and 4 give wrong positions. For one set of points, the method gives no answer: the information is not rich enough. This is a good point of the method. These results do not take the ambiguity seen above into account.

To improve these results, the robot moves in the environment. Different set of points for the same environment configuration are then obtained. The information contained in these sets of points are complementary because the obstacle does not hide the same part of the environment. The 14 sets of points studied come from 4 different environment configurations. They are representative of the reality: one of them has no obstacle, three others have an obstacle at different places along the walls of the room. Grouping the different scanings of each configuration gives better results. Two positions are well determined positions (less than 20cm and 10° error), and two others are mean (less than 40cm and 20° error).

With neural networks

With or without obstacle, with several points of view or not, an ambiguity subsists if only the cost function is taken into account to determine the best position between the proposed ones. Only the door breaks off the symmetry of the rectangle. From two symmetrical positions given by the method, a neural network permits selection of the right one.

In the cases of the 18 sets of points studied with the neural network, the robot localisation gives no results in one case. On the 17 others, criterion C is given on Figure 14. Its sign gives the best position. C has been computed to be positive for the good position. In only one case (number 10), it is negative. Its absolute value is less than 0.1. In all the other cases, it is positive, and it is bigger than 0.25. A decision threshold is fixed to 0.2 for $|C|$. The ambiguity is solved in 16 cases on 17. In the last case, $|C| < 0.2$ and no decision is taken. More information is required to conclude. It is interesting to point out that no wrong choice is taken.

Method of the rectangle modified with multiple echoes

Results of the method of the rectangle show that performances are worse if there is an obstacle in the environment. Thanks to the second echo the wall, even with an obstacle, can be seen. First results are encouraging. Figure 15 represents a set of points taken in the room with only first echoes. The wall on the left is well seen. But, on the right, the obstacle masks the longest part of the wall. Segment construction gives a segment corresponding to the obstacles and not to the wall.

If second echoes are taken into account (Figure 16), the right wall appears more clearly.

In this case, a group of five segments appears (Figure 17). The first echo draws the obstacle and the second echo draws the wall. Simple geometrical reasoning permits elimination of the perturbing segment. If two segments are parallel on the same side of the robot, the nearest is rejected. Indeed, if the room is supposed to be rectangular, the rejected segment represents an obstacle. Then, the wall is seen and can be used in the localisation process.

In this example (Figure 17), the computed segment due to the obstacle is rejected and the right position is found.

CONCLUSION AND FURTHER WORK

Autonomy of a mobile robot depends on three functions: planification, navigation and localisation. The strong constraint exposed in the introduction, i.e. the cost of the disabled people assistance, obliges to use a perception system of mean metrological quality and limited treatment power. In this context, localisation poses new problems. It is particularly true when the robot is lost in a room with unknown obstacles.

The method of the rectangle, completed by the recognition of landmarks by a neural network, gives an adapted solution to the characteristics of the ultrasonic measures.

Results show that the method of the rectangle, with four positions for the obstacle in the environment, gives two good positions (less than 20cm and 10° of error) and two mean positions (less than 40cm and 20° of error) on four cases. The door detection using a neural network and the knowledge of the proposed solutions by the method of the rectangle gives good results: 16 good detections on 17 and 1 no-detection.

As we know, it is the first time that absolute localisation with ultrasonic sensors in partially known environment has been performed.

Two improvements are proposed. The first one is to take into account several echoes (2 for beginning) to palliate the masking of the walls by obstacles. That must be evaluated.

The method of the rectangle can be generalised to rooms with more complex patterns. Not only rectangles must be searched but all kinds of sets of perpendicular segments. These two points are presently on our spot.

BIBLIOGRAPHY

- [1] P. Dario, E. Guglielmelli, B. Allotta, M.C. Carrozza : « Robotics for medical applications » - IEEE Robotics and Automation Magazine, Sept 1996, pp 44-56.
- [2] P. Hoppenot, M. Benreguieg, H. Maaref, E. Colle and C. Barret : « Control of a medical aid mobile robot based on a fuzzy navigation » - IEEE Symposium on Robotics and Cybernetics, July 1996, pp 388-393.
- [3] J. Borenstein : « Measurement and correction of systematic odometry errors in mobile robots » - IEEE Trans on Rob and Auto, vol. 12, N°6, dec 1996, pp869-880.
- [4] J.L. Crowley. : « World modeling and position estimation for a mobile robot using ultrasonic ranging » - IEEE Int. Conf. on Robotics and Automation, 1989, pp 674-680.

P. Hoppenot, E. Colle and C. Barat: "Off line localisation of a mobile robot using ultrasonic measures" - Robotica, Vol 18, pp.315-323, 2000.

- [5] B.J.A. Kröse, K.M. Compagner. and F.C.A. Groen : « Accurate estimation of environment parameters from ultrasonic data » - Robotics and Autonomous systems 11 (93), pp 221-230.
- [6] P.J. Mc Kerrow : « Echolocation - from range to outline segments » - Robotics and Autonomous systems 11 (93) 205-211.
- [7] J. Cox : « Blanche - an experiment in guidance and navigation of an autonomous robot vehicle" - IEEE Trans on Rob and Aut, vol 7, n°2, April 91, pp 193-204.
- [8] A. Elfes : « A sonar-based mapping and navigation system » - IEEE International conference on robotics and automation, April 86, pp 1151-1156.
- [9] L. Matthies, A. Elfes - « Integration of sonar and stereo range data using a grid-based representation » - IEEE Int Conf on Rob and Aut, 88, pp 727-733.
- [10] B Schiele and J.L. Crowley : « A comparison of position estimation techniques using occupancy grids » - IEEE International Conference on Robotics and Automation, San Diego, may 1994, 1628-1634.
- [11] J.J. Leonard, H.F. Durrant-Whyte : « Mobile robot localisation by tracking geometric beacons » - IEEE Transaction on Robotics and Automation, 1991, 7(3), 376-382.
- [12] G. Lawitzky, W. Feiten, M. Möller : « Sonar sensing for low-cost indoor mobility » - Robotics and Autonomous Systems 14, 95, pp149-157.
- [13] Ö. Bozma, R. Kuc : « Building a sonar map in a specular environment using a single mobile sensor » - IEEE Trans on Pattern Analysis and Machine Intelligence, vol 13, n°12, Dec 1991, pp 1260-1269.
- [14] L. Peyrodie : « Reconstruction d'un univers de téléopération à l'aide d'un capteur à ultrasons » - Thèse de doctorat, Université de Lille, 8 novembre 1996.
- [15] P. Hoppenot, E. Colle : « Real-time mobile robot localisation with poor ultrasonic data » - 3rd IFAC Symposium on Intelligent Component and Instrument for Control Application (SICICA), 9-11 June 1997, pp 135-140.
- [16] T. Kohonen : « Self-Organizing Maps » - Springer-Verlag, 1995.
- [17] L. Holmström, P. Koistinen, J. Laaksonen, E. Oja : « Neural and statistical classifiers - Taxonomy and two case studies » - IEEE Trans on NN, vol. 8, n°1, Jan. 1997, pp 5-17.
- [18] E. Connessons, C. Vasiljevic, C. Barret : - « Discrimination method comparison for mobile object recognition » - IEEE International Conference on Advances in Vehicle Control Safety, 1998, pp 69-74.
- [19] C. Bishop : « Neural network for pattern recognition » -Clarendon Press, Oxford 1995
- [20] B. Barshan, R. Kuc : « Differentiating sonar reflections from corners and planes by employing an intelligent sensor » - IEEE Trans on Pattern Analysis and Machine Int. vol; 12, n°6, June 1990, pp 560-569.

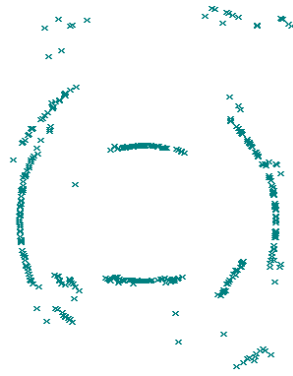

Figure 1: *Ultrasonic measures in a room without obstacle.*

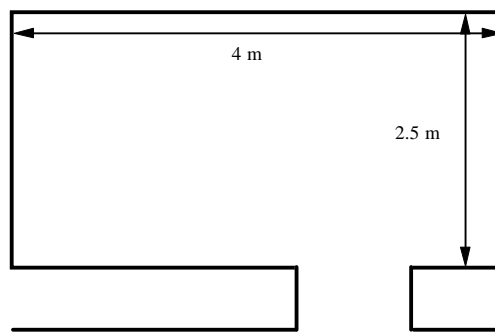

Figure 2: *Environment map of the robot.*

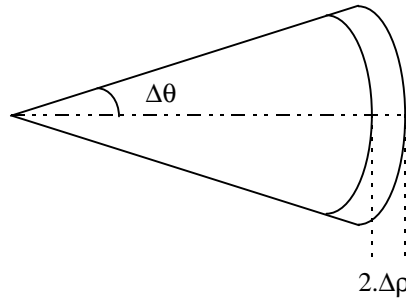

Figure 3: *Ultrasonic sensor metrological characteristics.*

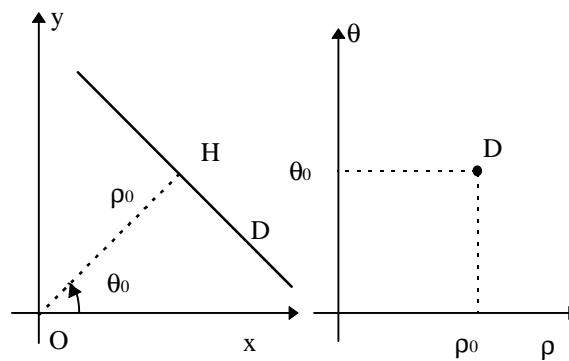

Figure 4: *Hough transform representation.*

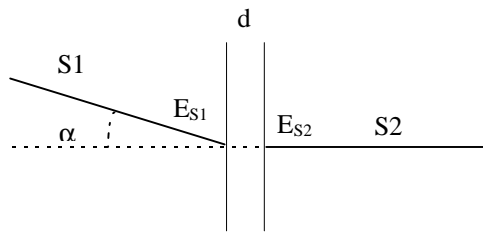

Figure 5: α and d definition.

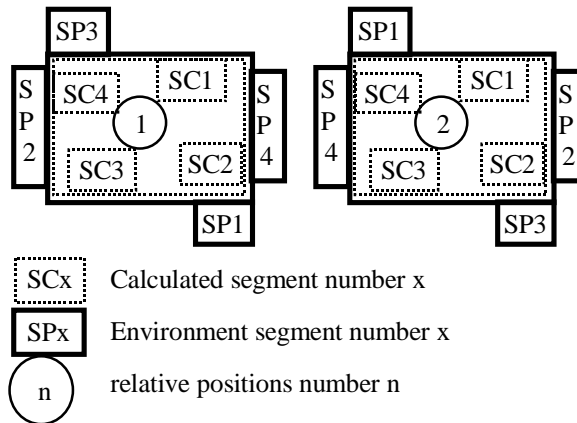

Figure 6: Relative Position of calculated segments and environment.

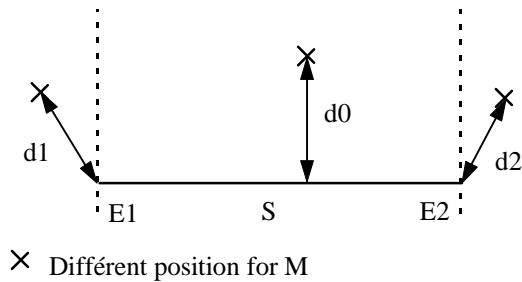

Figure 7: Calculus of the distance between a point and a segment.

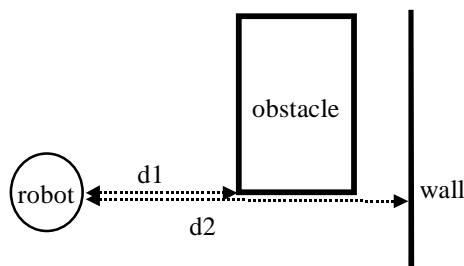

Figure 8: Second echo giving the distance to the wall.

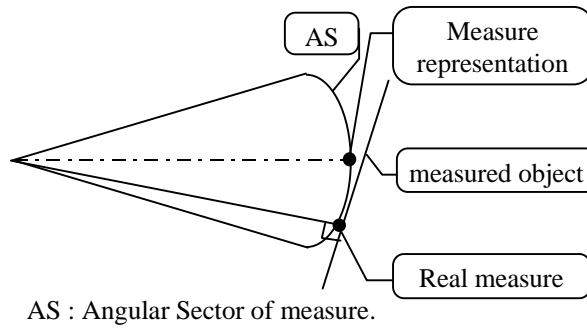

Figure 9: Measure representation.

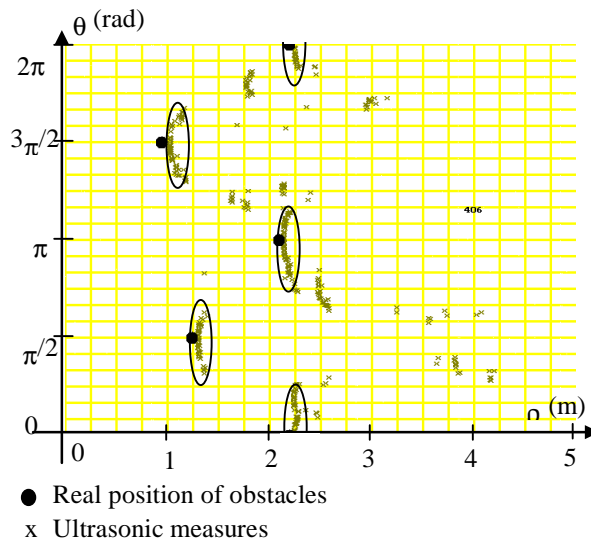

Figure 10: Uncertainty ellipsis of a straight line in a plane.

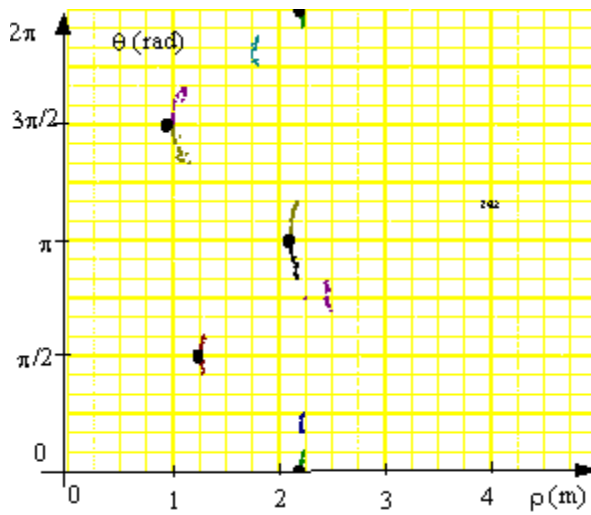

Figure 11: Groups of points in (ρ, θ) plane.

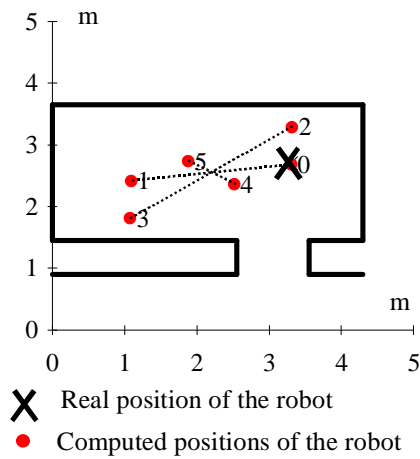

Figure 12: Localisation example without obstacle.

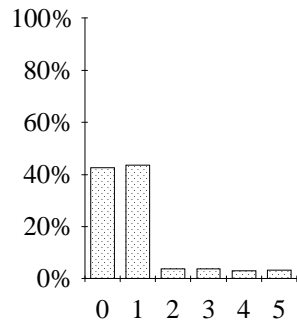

Figure 13: Cost function without obstacle.

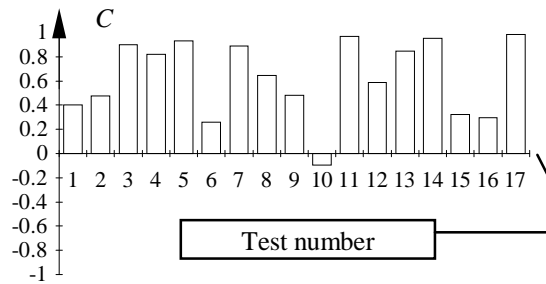

Figure 14: C criteria for the position choice.

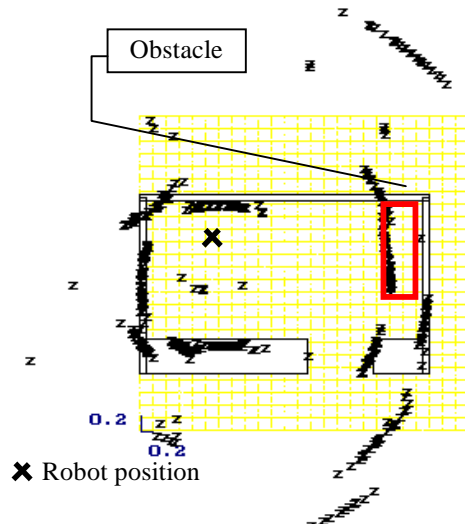

Figure 15: Set of points with only first echoes.

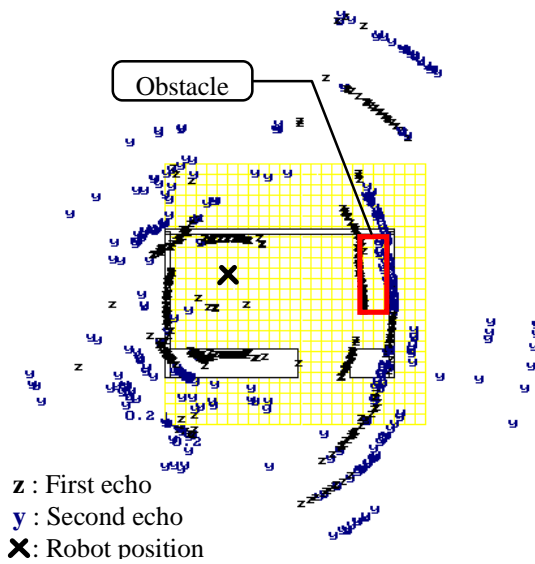

Figure 16: Set of points with two echoes.

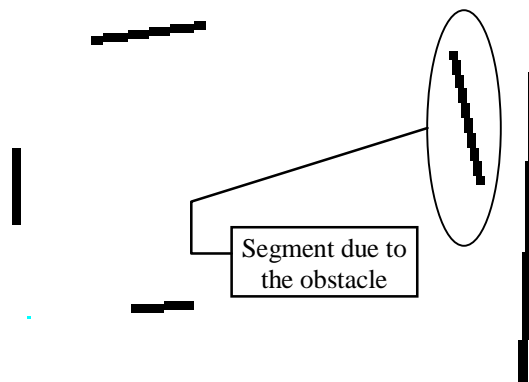

Figure 17: Group of five segments.